

Claber Video 2 Plus

Connect the timer to the tap.

1

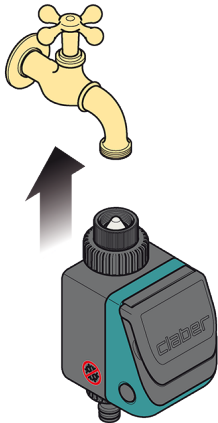

2

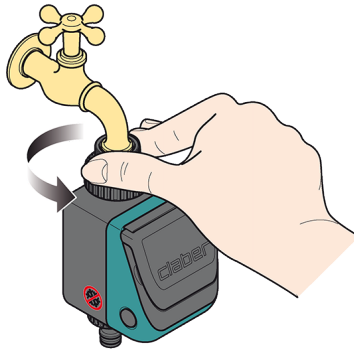

3

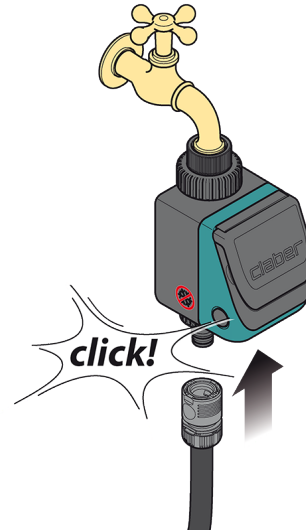

For Aquauno Video 2 (p/n): 8454
For Aquauno Video 2 Plus (p/n): 8412

Open the timer unit by pressing the two buttons on the sides, and fit a 9V alkaline battery. When connecting the battery, the display comes on, the valve opens for 2 seconds and the timer clock will be set automatically to 00:00. **Important:** Remember to turn on the water tap.

1

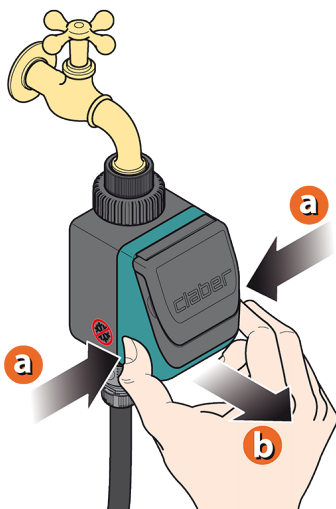

2

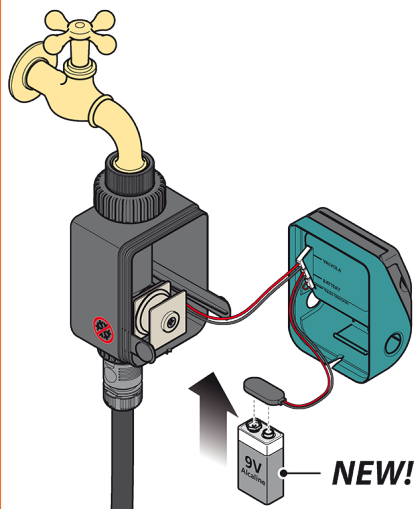

3

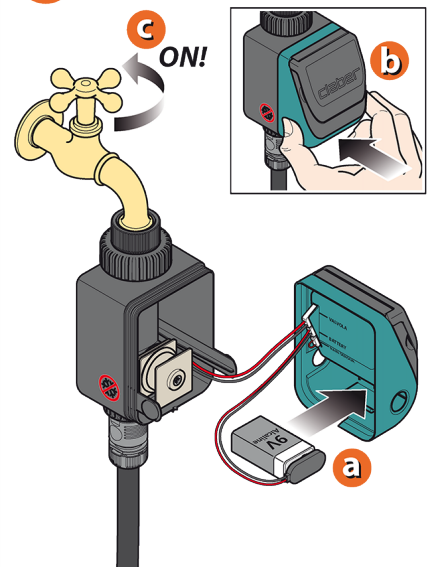

For Aquauno Video 2 (p/n): 8454
For Aquauno Video 2 Plus (p/n): 8412

Claber Video 2 Plus

4 ON!

5 open for 2"

6

For Aquauno Video 2 (p/n): 8454
For Aquauno Video 2 Plus (p/n): 8412

Pressing the ENTER key button, the message OK will appear. Set the current time using the FORWARD/BACK key buttons. Keeping the FORWARD or BACK key buttons pressed, the numbers will scroll more quickly. Having set the time, press ENTER, and the message OK will appear.

1 x 1 a

2 forward back a

3 x 1 a

For Aquauno Video 2 (p/n): 8454
For Aquauno Video 2 Plus (p/n): 8412

Claber Video 2 Plus

Programming is managed by way of pages presented in the display. Each page has two functions: view programme and, pressing ENTER, modify programme. Pressing FORWARD, the display will show the second programme of the line.

1

2

3

a

b

c

d

PROGRAMME 1 ON (OPEN) ⇨ ENTER
PROGRAMME 1 OFF (CLOSED) ⇨ ENTER
PROGRAMME 2 ON (OPEN) ⇨ ENTER
PROGRAMME 2 OFF (CLOSED) ⇨ ENTER

For Aquauno Video 2 (p/n): 8454
 For Aquauno Video 2 Plus (p/n): 8412

Suppose watering is to be programmed from the current time (e.g. 10:42). Press the FORWARD button once. The display shows "1=progr.1 OPEN". The time appears as 00:00; press ENTER to set the opening time as required. The message OK means that the 'open' time can now be selected with the FORWARD/BACK key buttons. The symbol for programme 1 also appears at the top of the display. Having set the time (e.g. 5:00), press ENTER. The OK message disappears and the watering start time is stored.

1

2

3

For Aquauno Video 2 (p/n): 8454
 For Aquauno Video 2 Plus (p/n): 8412

Claber Video 2 Plus

Press the FORWARD key button once. The display shows "1=progr. 1 CLOSED". The timer sets the 'close' time automatically one minute after the 'open' time (in the example: 05:01). Press ENTER to set the 'close' time, in the same way as for the 'open' time (e.g. 05:20). Set the required 'close' time using the FORWARD/BACK key buttons. The symbol for programme 1 continues to be displayed after the programme has been stored. Press ENTER to conclude the programming procedure.

1

2

3

Follow the same procedure for programme **2**

For Aquauno Video 2 (p/n): 8454
For Aquauno Video 2 Plus (p/n): 8412

Pressing the FORWARD key button, the timer will move through to weekly programming. With weekly programming, the user can select in which days watering is required. Warning: day (1) coincides with the day on which the first watering cycle is set. Example: first programme set on Thursday = day (1). Warning: day (1) provides the reference point for weekly programming. Example: If Thursday = day (1) and the intention is to skip watering on Friday, the day to deselect is day (2). To omit one day of the week, position the cursor of the display under the number of the day in question, using the FORWARD/BACK key buttons. Press ENTER and the number will disappear.

1

2

3

For Aquauno Video 2 (p/n): 8454
For Aquauno Video 2 Plus (p/n): 8412

Claber Video 2 Plus

To quit the weekly programming page, position the cursor under EXIT and press ENTER. Press FORWARD to display the manual watering function. Press ENTER to activate the manual function; pressing the BACK key button (OPEN), the timer valve opens, and pressing the FORWARD key button (CLOSED), the valve closes. To quit the manual function, press ENTER. This function is useful for watering plants when required, without deleting the programmes already set. In any case, the valve will close automatically after 15 minutes.

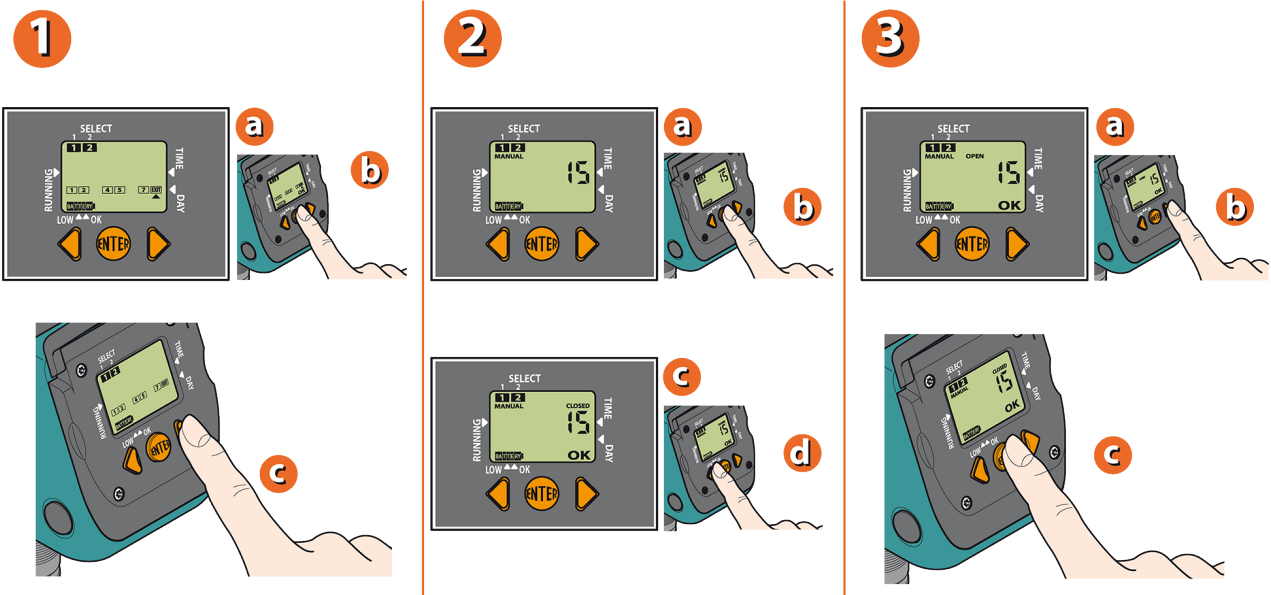

For Aquauno Video 2 (p/n): 8454
For Aquauno Video 2 Plus (p/n): 8412

To delete a programme, press FORWARD until the display shows the "CLOSED" page of the programme to be removed. Press ENTER, then press the FORWARD / BACK key buttons simultaneously.

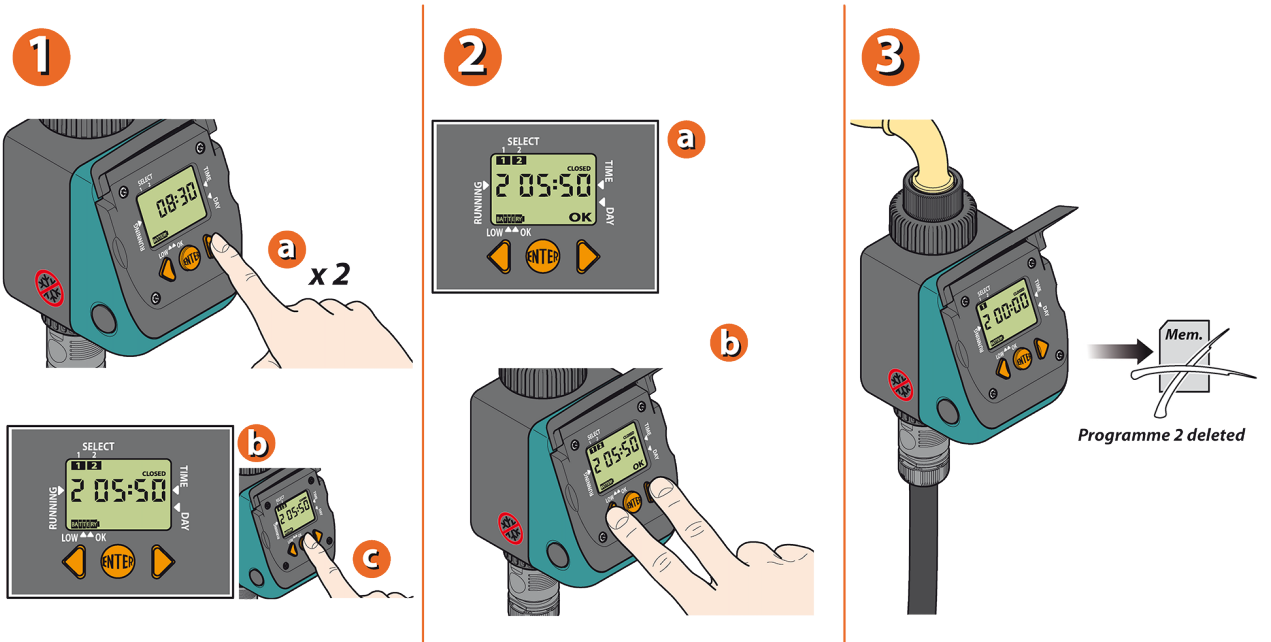

For Aquauno Video 2 (p/n): 8454
For Aquauno Video 2 Plus (p/n): 8412

Claber Video 2 Plus

The timer can also be connected to the Rain Sensor, using the socket provided, in which case the protective jumper must be removed.

1

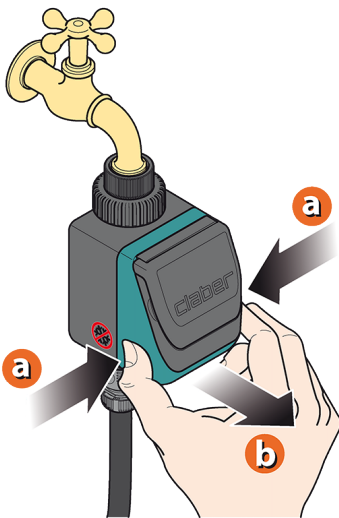

2

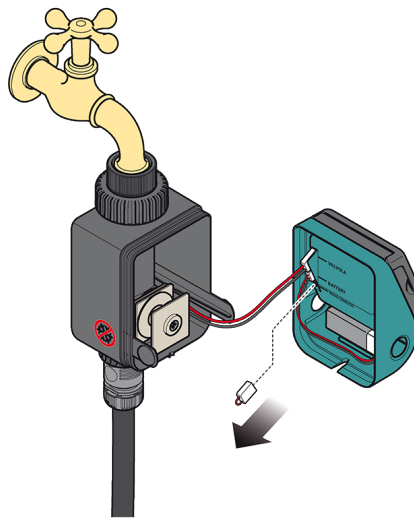

3

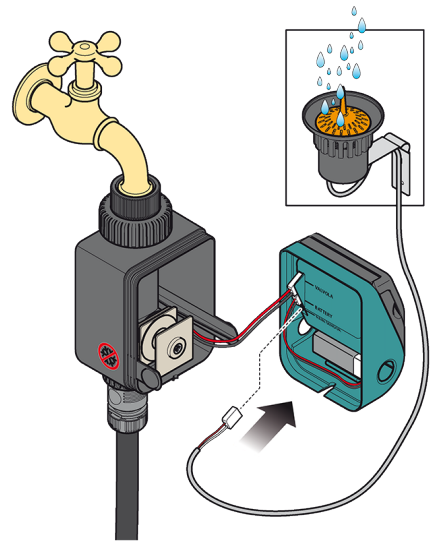

For Aquauno Video 2 Plus (p/n): 8412

At the end of the warm season and before the first winter frosts, disconnect the timer from the tap and store it indoors, bearing in mind to remove the battery.

1

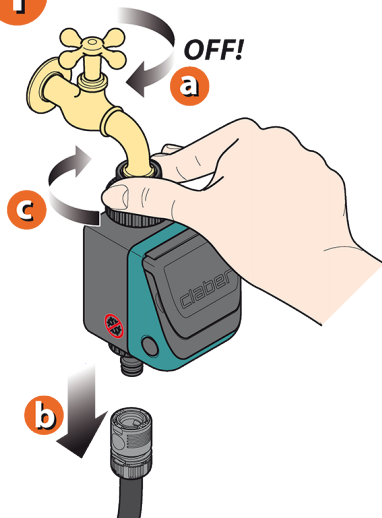

2

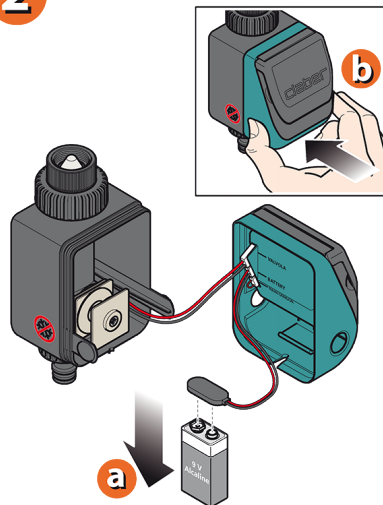

3

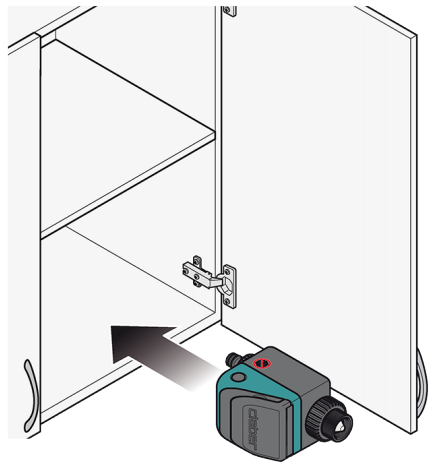

For Aquauno Video 2 (p/n): 8454
For Aquauno Video 2 Plus (p/n): 8412

For more information and further details, please consult the instruction manual supplied with the product.